

Information Theory & Fundamentals of Digital Communications

Network/Link Design Factors

- ❖ Transmission media
 - Signals are transmitted over transmission media
 - Examples: telephone cables, fiber optics, twisted pairs, coaxial cables
- ❖ Bandwidth (εύρος ζώνης)
 - Higher bandwidth gives higher data rate
- ❖ Transmission impairments
 - Attenuation (εξασθένηση)
 - Interference (παρεμβολή)
- ❖ Number of receivers
 - In guided media
 - More receivers (multi-point) introduce more attenuation

Channel Capacity

❖ Data rate

- In bits per second
- Rate at which data can be communicated
- Baud rate (symbols/sec) \neq bit rate (bits/sec)
 - Number of symbol changes made to the transmission medium per second
 - One symbol can carry more than one bit of information

❖ Bandwidth

- In cycles per second, or Hertz
- Constrained by transmitter and transmission medium

Data Rate and Bandwidth

- ❖ Any transmission system has a limited band of frequencies
- ❖ This limits the data rate that can be carried
- ❖ E.g., telephone cables can carry signals within frequencies 300Hz – 3400Hz

Frequency content of signals

- ❖ http://www.allaboutcircuits.com/vol_2/chpt_7/2.html
- ❖ any repeating, non-sinusoidal waveform can be equated to a **combination of DC voltage, sine waves, and/or cosine waves** (sine waves with a 90 degree phase shift) at various amplitudes and frequencies.
- ❖ This is true no matter how strange or convoluted the waveform in question may be. So long as it repeats itself regularly over time, it is reducible to this series of sinusoidal waves.

Fourier series

- ❖ Mathematically, any repeating signal can be represented by a series of sinusoids in appropriate weights, i.e. a Fourier Series.

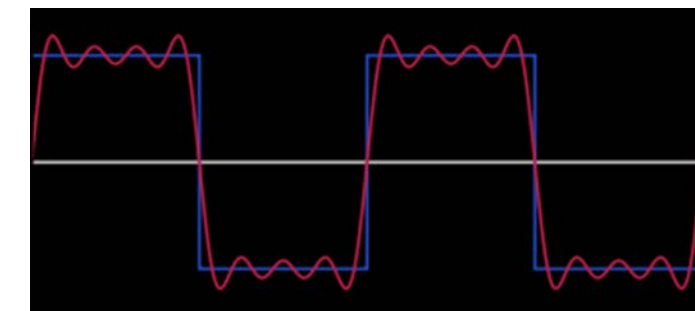
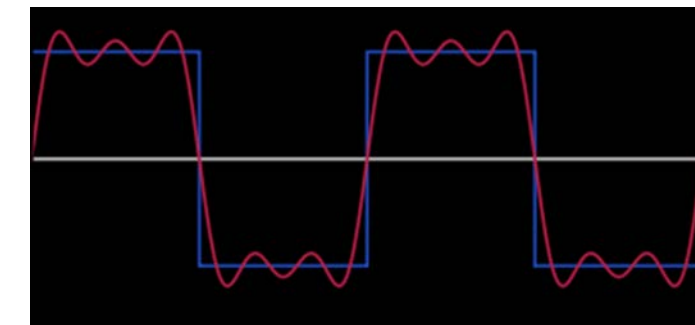
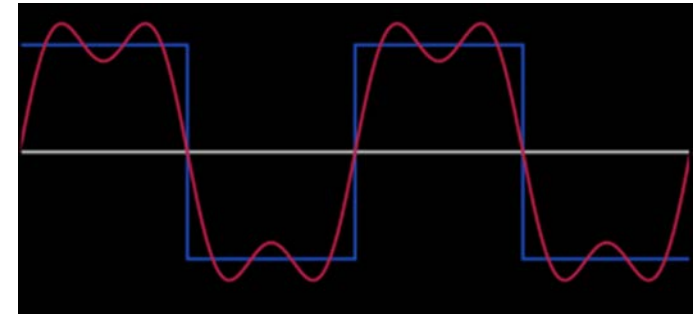
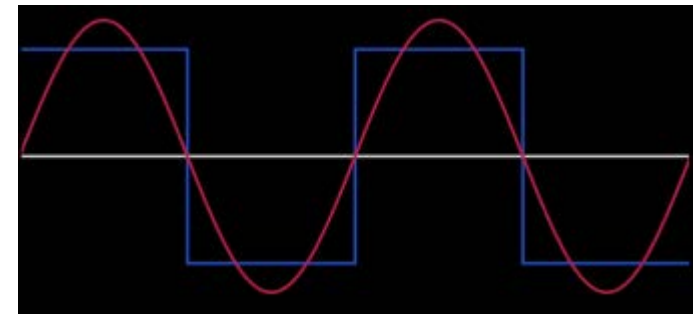

- ❖ http://en.wikipedia.org/wiki/Fourier_series

The Mathematic Formulation

- ❖ A periodic function is any function that satisfies

$$f(t) = f(t + T)$$

where T is a constant and is called the *period* of the function.

Note: for a sinusoidal waveform the frequency is the reciprocal of the period ($f=1/T$)

Synthesis

$$f(t) = \underbrace{\frac{a_0}{2}}_{\text{DC Part}} + \underbrace{\sum_{n=1}^{\infty} a_n \cos \frac{2\pi n t}{T}}_{\text{Even Part}} + \underbrace{\sum_{n=1}^{\infty} b_n \sin \frac{2\pi n t}{T}}_{\text{Odd Part}}$$

T is a period of all the above signals

Let $\omega_0 = 2\pi/T$.

$$f(t) = \frac{a_0}{2} + \sum_{n=1}^{\infty} a_n \cos(n\omega_0 t) + \sum_{n=1}^{\infty} b_n \sin(n\omega_0 t)$$

Example (Square Wave)

$$f(t) = \frac{1}{2} + \frac{2}{\pi} \left(\sin t + \frac{1}{3} \sin 3t + \frac{1}{5} \sin 5t + \dots \right)$$

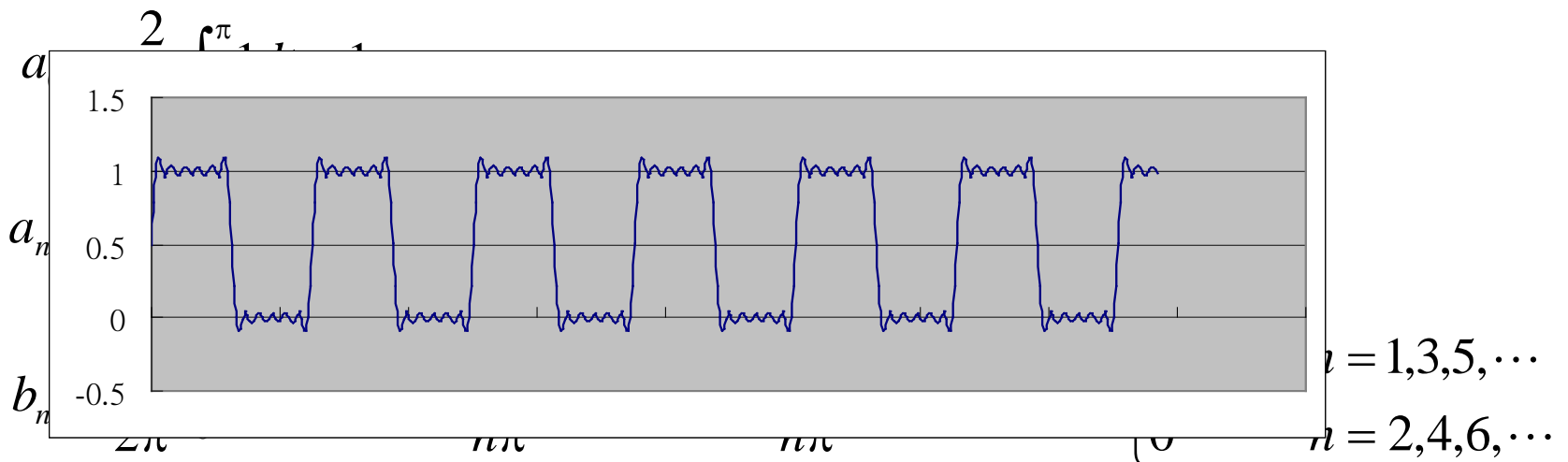
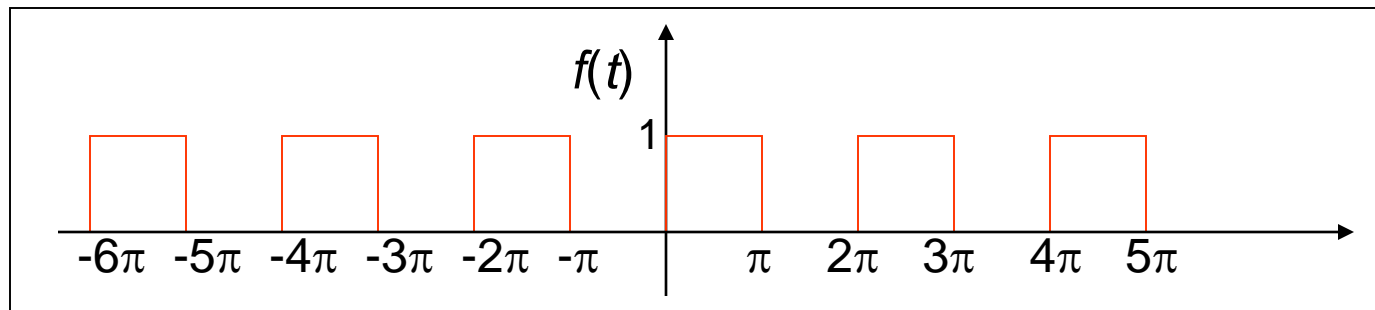

Fourier series example

- ❖ Thus, **square waves (and indeed and waves)** are mathematically equivalent to the sum of a sine wave at that same frequency, plus an infinite series of odd-multiple frequency sine waves at diminishing amplitude

1 V (peak) repeating square wave at 50 Hz is equivalent to:

$$\begin{aligned} & \left(\frac{4}{\pi}\right) (1 \text{ V peak sine wave at } 50 \text{ Hz}) \\ & + \left(\frac{4}{\pi}\right) (1/3 \text{ V peak sine wave at } 150 \text{ Hz}) \\ & + \left(\frac{4}{\pi}\right) (1/5 \text{ V peak sine wave at } 250 \text{ Hz}) \\ & + \left(\frac{4}{\pi}\right) (1/7 \text{ V peak sine wave at } 350 \text{ Hz}) \\ & + \left(\frac{4}{\pi}\right) (1/9 \text{ V peak sine wave at } 450 \text{ Hz}) \\ & + \dots \textit{ad infinitum} \dots \end{aligned}$$

Another example

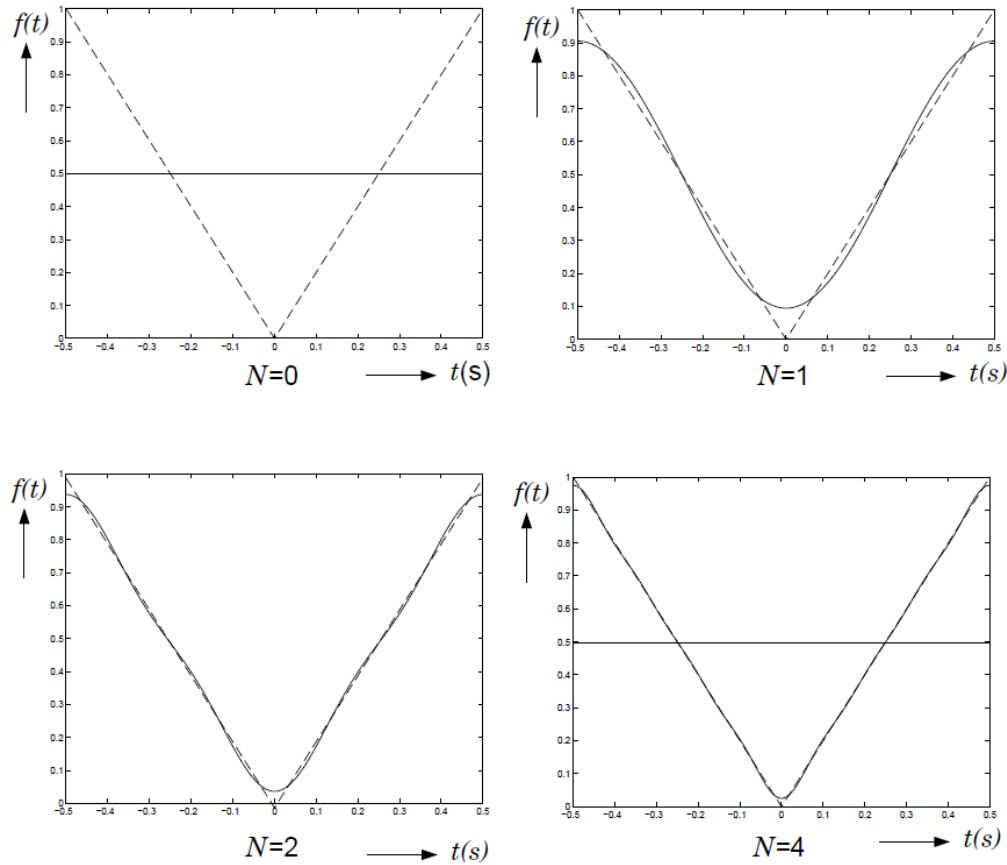

Figure 3: Fourier representation of a triangular wave when the series is truncated at the N th term.

With 4 sinusoids we represent quite well a triangular waveform

- ❖ The ability to represent a waveform as a series of sinusoids can be seen in the opposite way as well:
- ❖ What happens to a waveform if sent through a bandlimited (practical) channel
- ❖ E.g. some of the higher frequencies are removed, so signal is distorted...
- ❖ E.g. what happens if a square waveform of period T is sent through a channel with bandwidth $(2/T)$?

The Electromagnetic Spectrum

The electromagnetic spectrum and its uses for

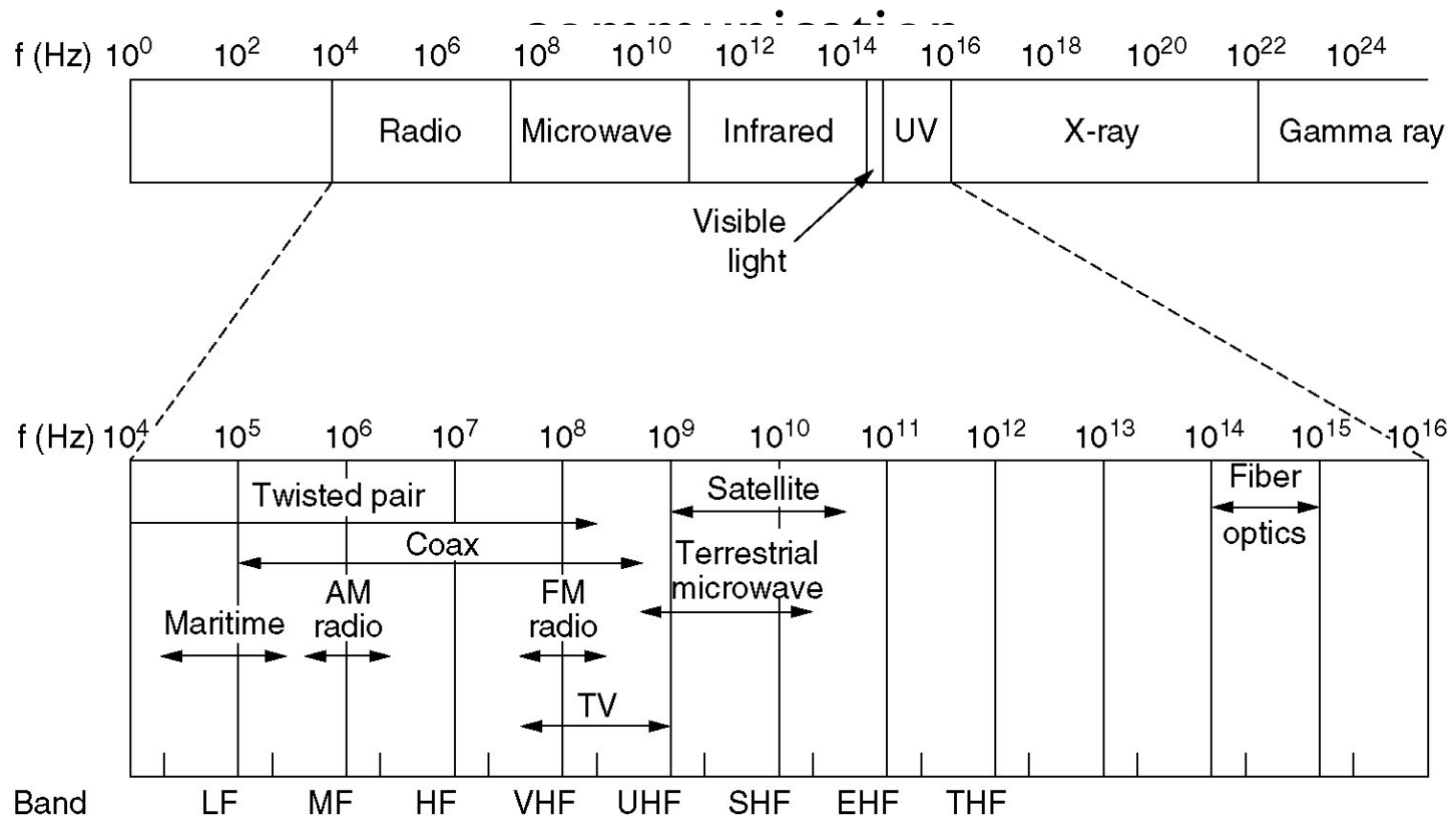

Electromagnetic Spectrum

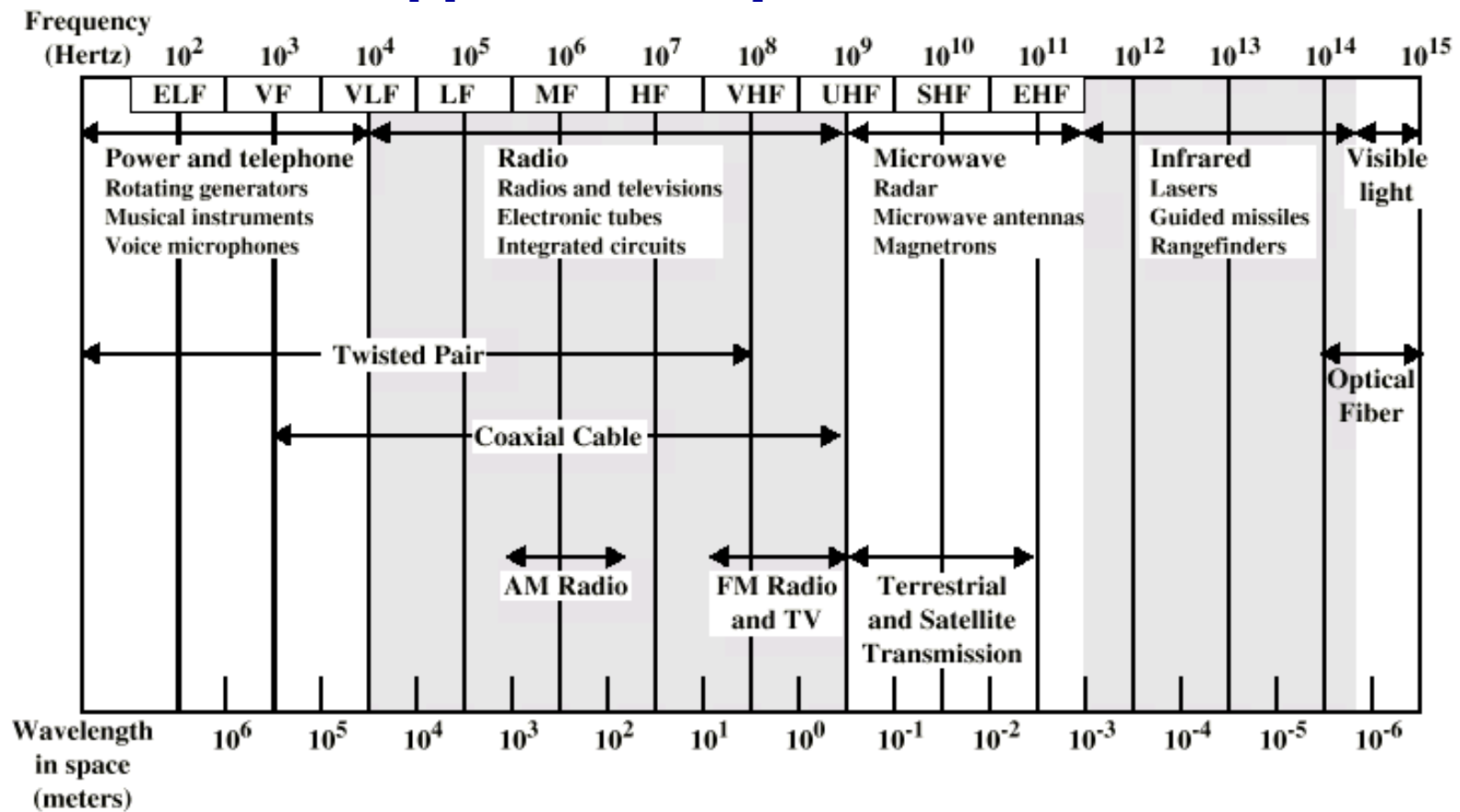

ELF = Extremely low frequency
 VF = Voice frequency
 VLF = Very low frequency
 LF = Low frequency

MF = Medium frequency
 HF = High frequency
 VHF = Very high frequency

UHF = Ultrahigh frequency
 SHF = Superhigh frequency
 EHF = Extremely high frequency

- ❖ Generally speaking there is a push into higher frequencies due to:
 - efficiency in propagation,
 - immunity to some forms of noise and impairments as well as the size of the antenna required.
 - The antenna size is typically related to the wavelength of the signal and in practice is usually $\frac{1}{4}$ wavelength.

Data and Signal: Analog or Digital

❖ Data

- Digital data – discrete value of data for storage or communication in computer networks
- Analog data – continuous value of data such as sound or image

❖ Signal

- Digital signal – discrete-time signals containing digital information
- Analog signal – continuous-time signals containing analog information

Periodic and Aperiodic Signals (1/4)

- ❖ Spectra of periodic analog signals: **discrete**

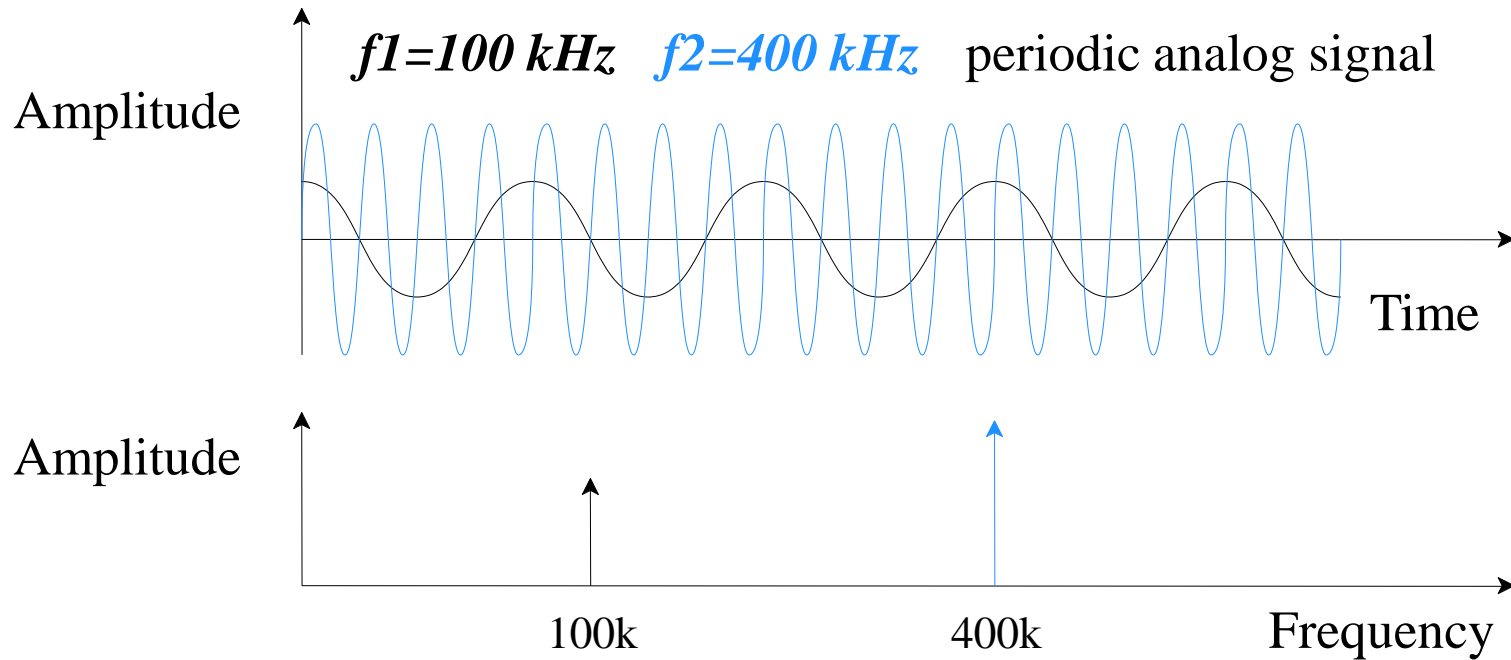

Periodic and Aperiodic Signals (2/4)

- ❖ Spectra of aperiodic analog signals: **continuous**

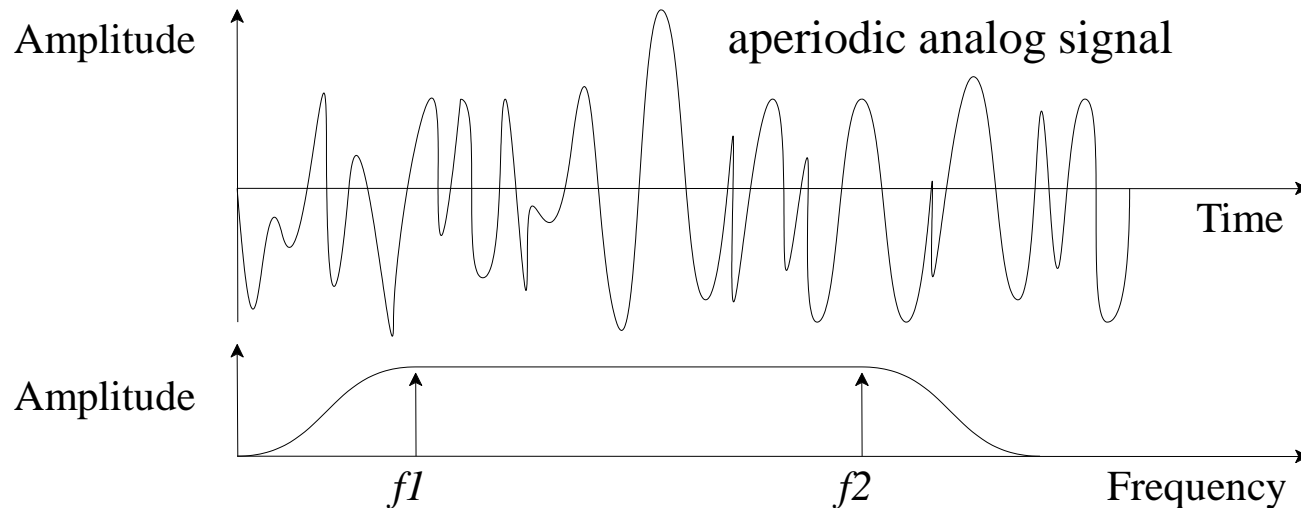

Periodic and Aperiodic Signals

(3/4)

- ❖ Spectra of periodic digital signals: **discrete (frequency pulse train, infinite)**

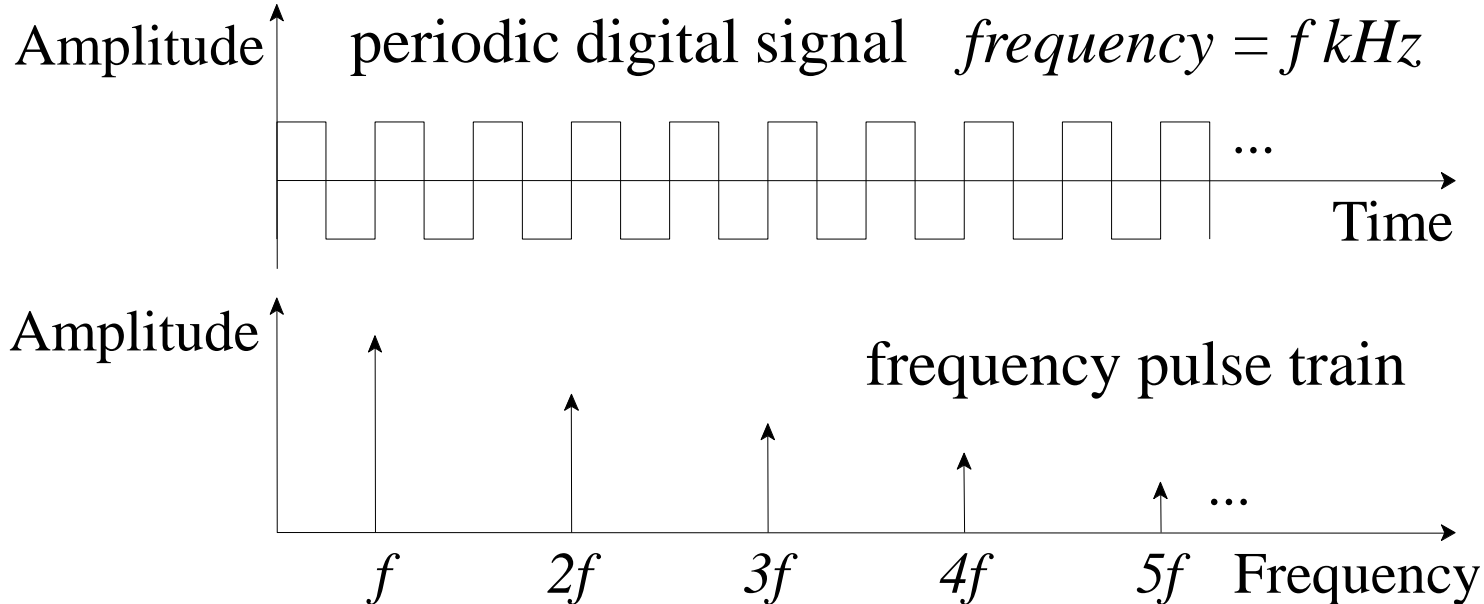

Periodic and Aperiodic Signals (4/4)

- ❖ Spectra of aperiodic digital signals: **continuous**
(infinite)

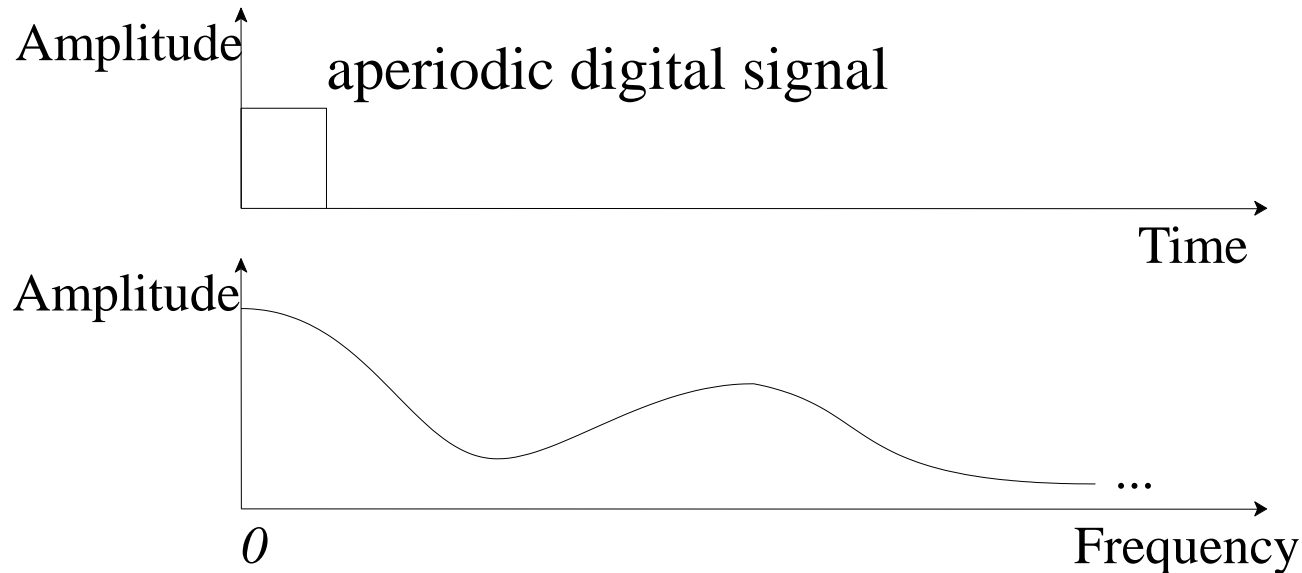

Sine Wave

- ❖ Peak Amplitude (A)
 - maximum strength of signal
 - volts
- ❖ Frequency (f)
 - Rate of change of signal
 - Hertz (Hz) or cycles per second
 - Period = time for one repetition (T)
 - $T = 1/f$
- ❖ Phase (ϕ)
 - Relative position in time

Varying Sine Waves

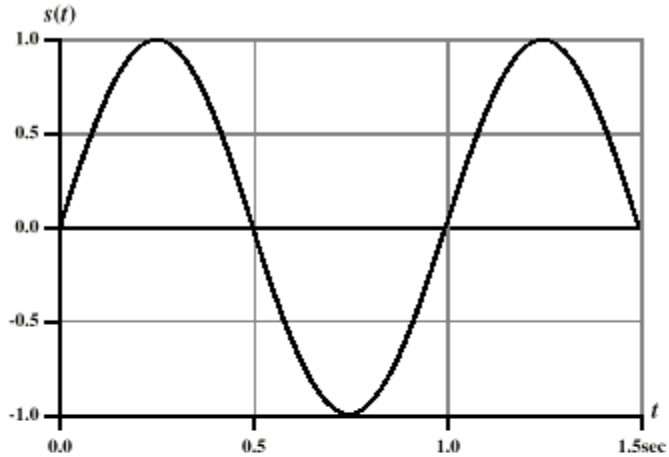

(a) $A = 1, f = 1, \phi = 0$

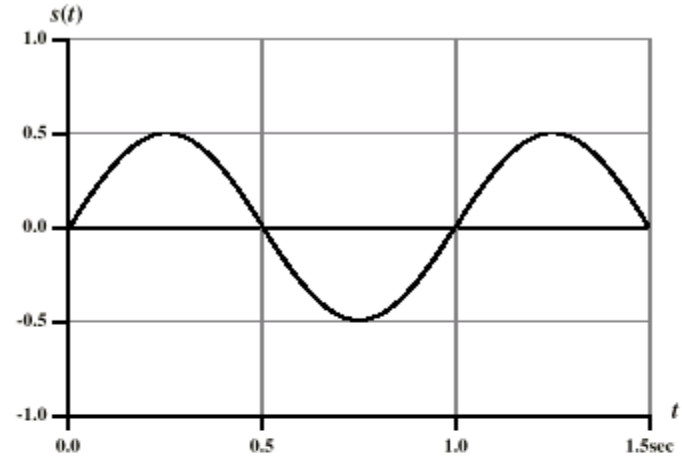

(b) $A = 0.5, f = 1, \phi = 0$

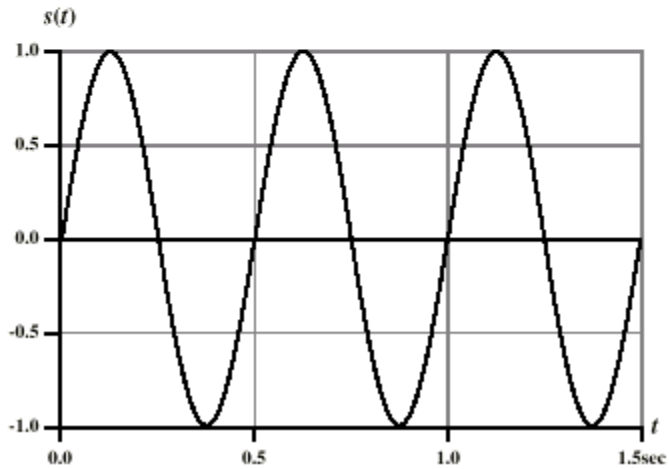

(c) $A = 1, f = 2, \phi = 0$

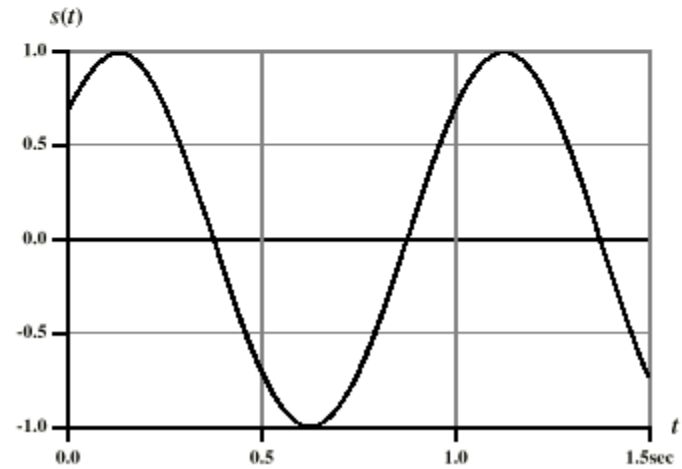

(d) $A = 1, f = 1, \phi = \pi/4$

Signal Properties

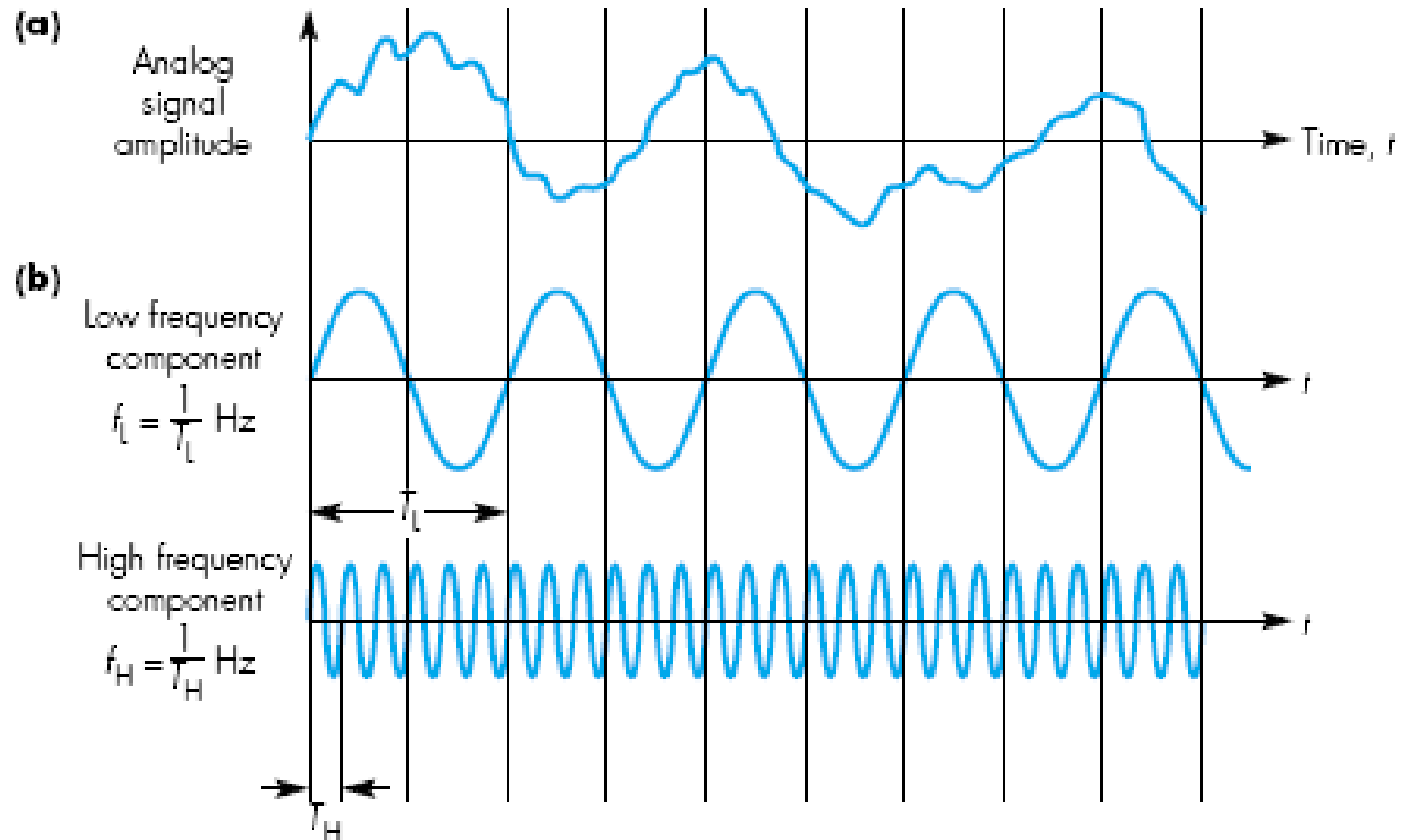

$T_{L/H}$ = time for one cycle = signal period

Baseband Transmission

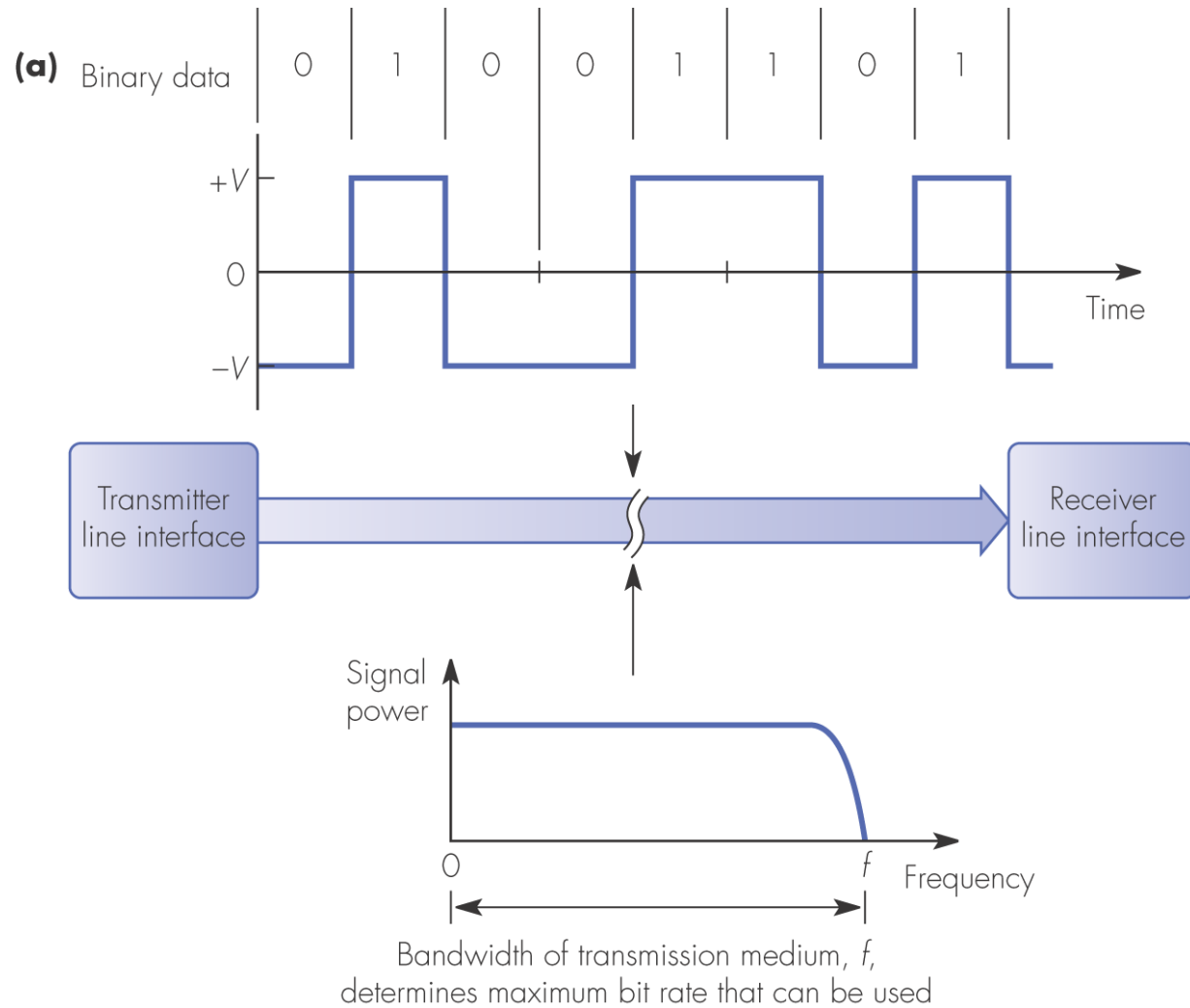

Figure 1.8 Modes of transmission: (a) baseband transmission

Modulation (Διαμόρφωση)

- ❖ Η διαμόρφωση σήματος είναι μία διαδικασία κατά την οποία, ένα σήμα χαμηλών συχνοτήτων (baseband signal), μεταφέρεται από ένα σήμα με υψηλότερες συχνότητες που λέγεται φέρον σήμα (carrier signal)
- ❖ Μετατροπή του σήματος σε άλλη συχνότητα
- ❖ Χρησιμοποιείται για να επιτρέψει τη μεταφορά ενός σήματος σε συγκεκριμένη ζώνη συχνοτήτων π.χ. χρησιμοποιείται στο AM και FM ραδιόφωνο

Πλεονεκτήματα Διαμόρφωσης

- ❖ Δυνατότητα εύκολης μετάδοσης του σήματος
- ❖ Δυνατότητα χρήσης πολυπλεξίας (ταυτόχρονη μετάδοση πολλαπλών σημάτων)
- ❖ Δυνατότητα υπέρβασης των περιορισμών των μέσων μετάδοσης
- ❖ Δυνατότητα εκπομπής σε πολλές συχνότητες ταυτόχρονα
- ❖ Δυνατότητα περιορισμού θορύβου και παρεμβολών

Modulated Transmission

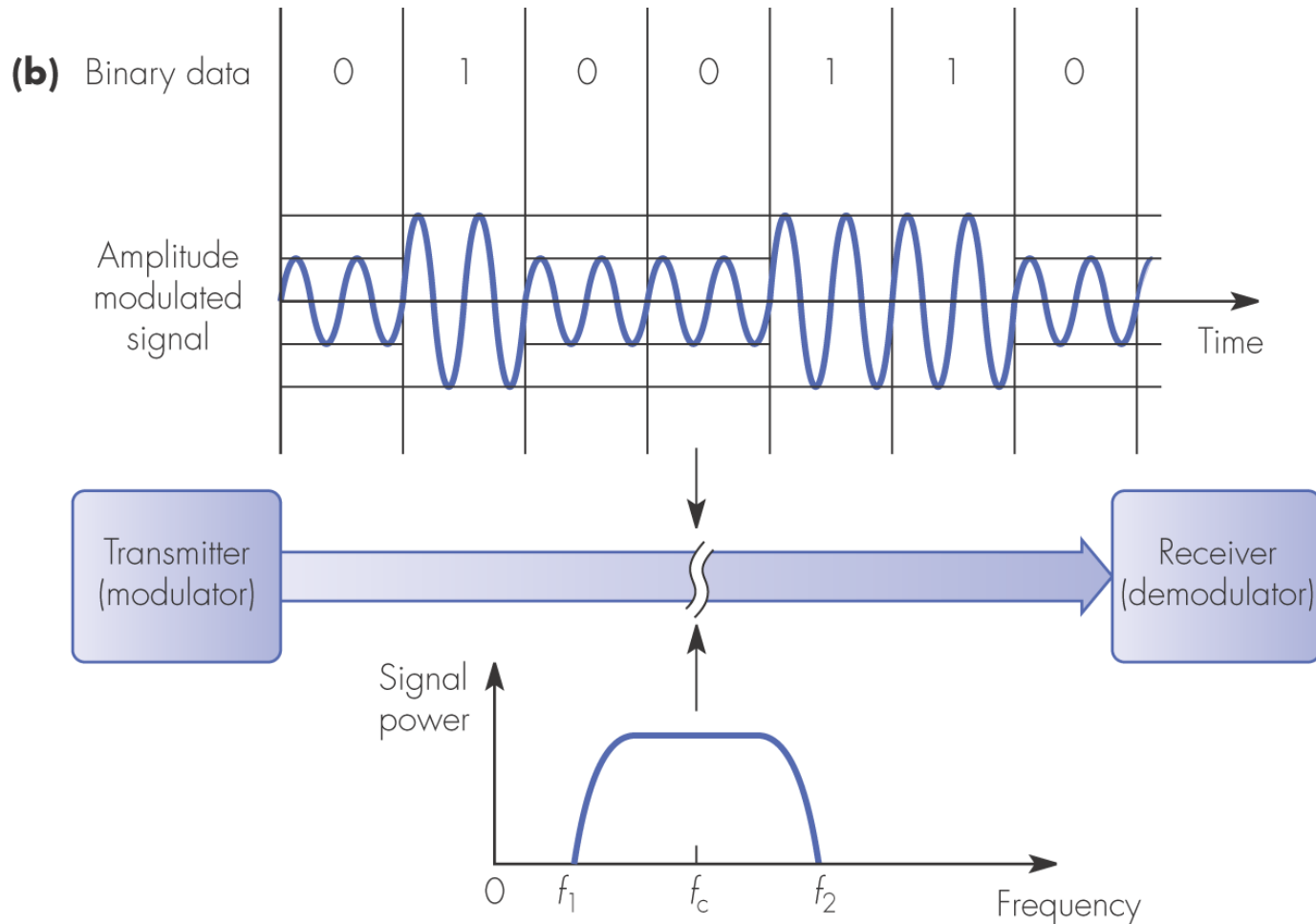

f_c = carrier signal (single-frequency audio tone)
Bandwidth ($f_2 - f_1$) determines maximum bit rate that can be used

Continuous & Discrete Signals

Analog & Digital Signals

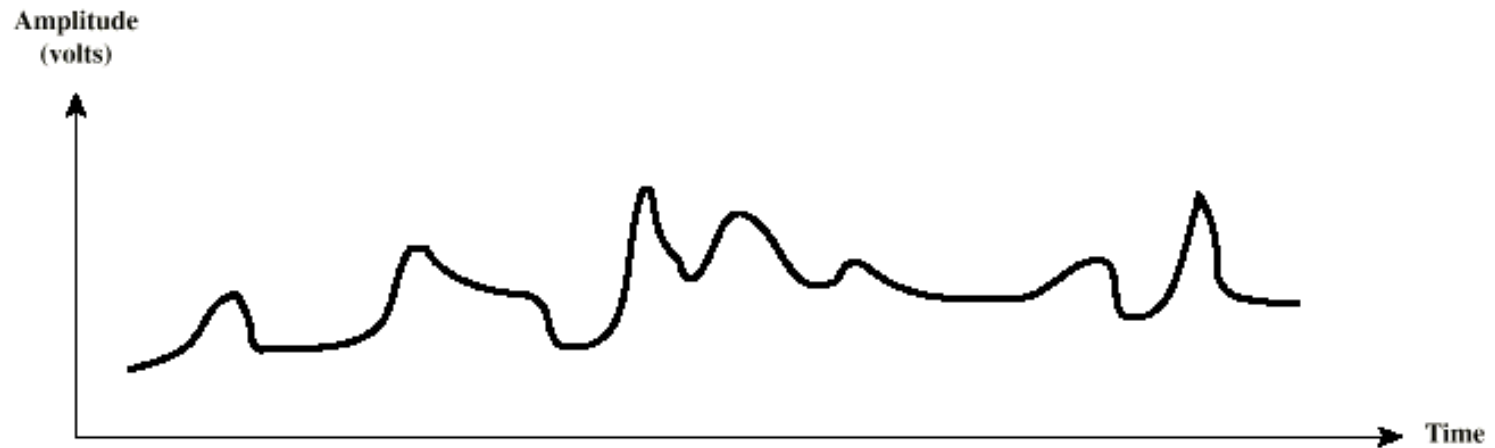

(a) Continuous

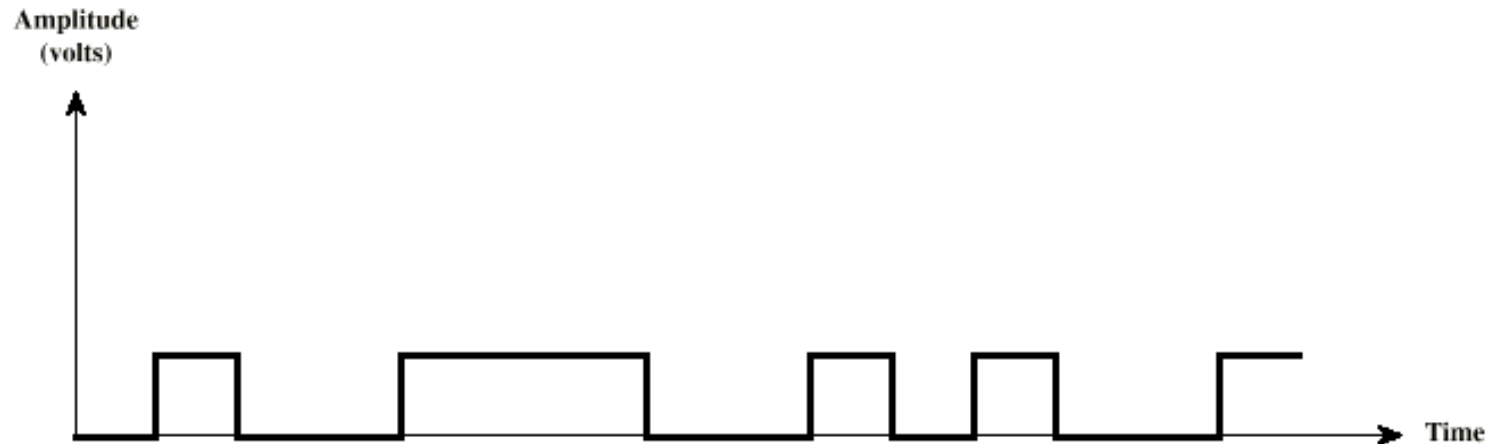

(b) Discrete

Analog Signals Carrying Analog and Digital Data

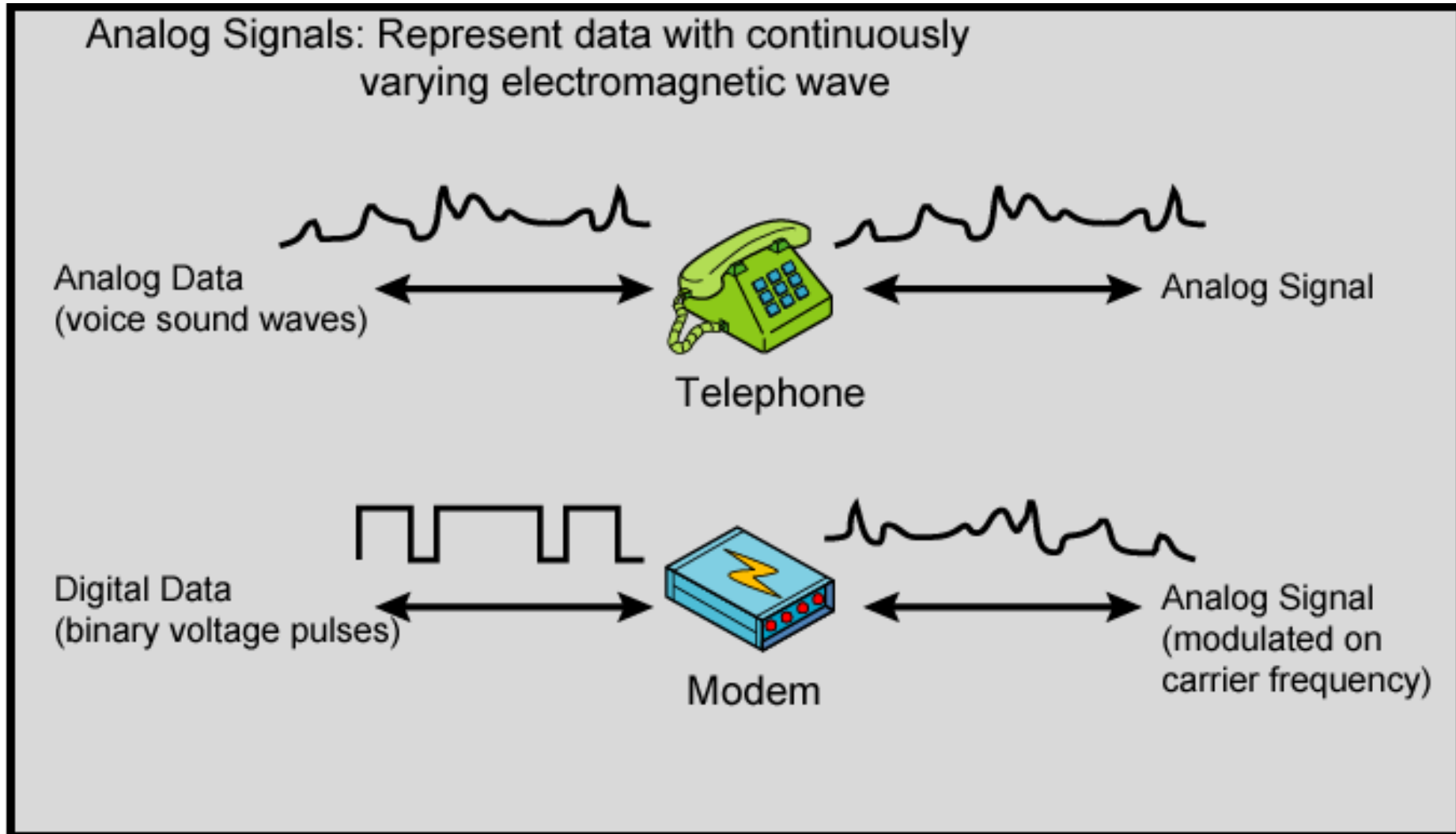

Digital Signals Carrying Analog and Digital Data

Digital Signals: Represent data with sequence of voltage pulses

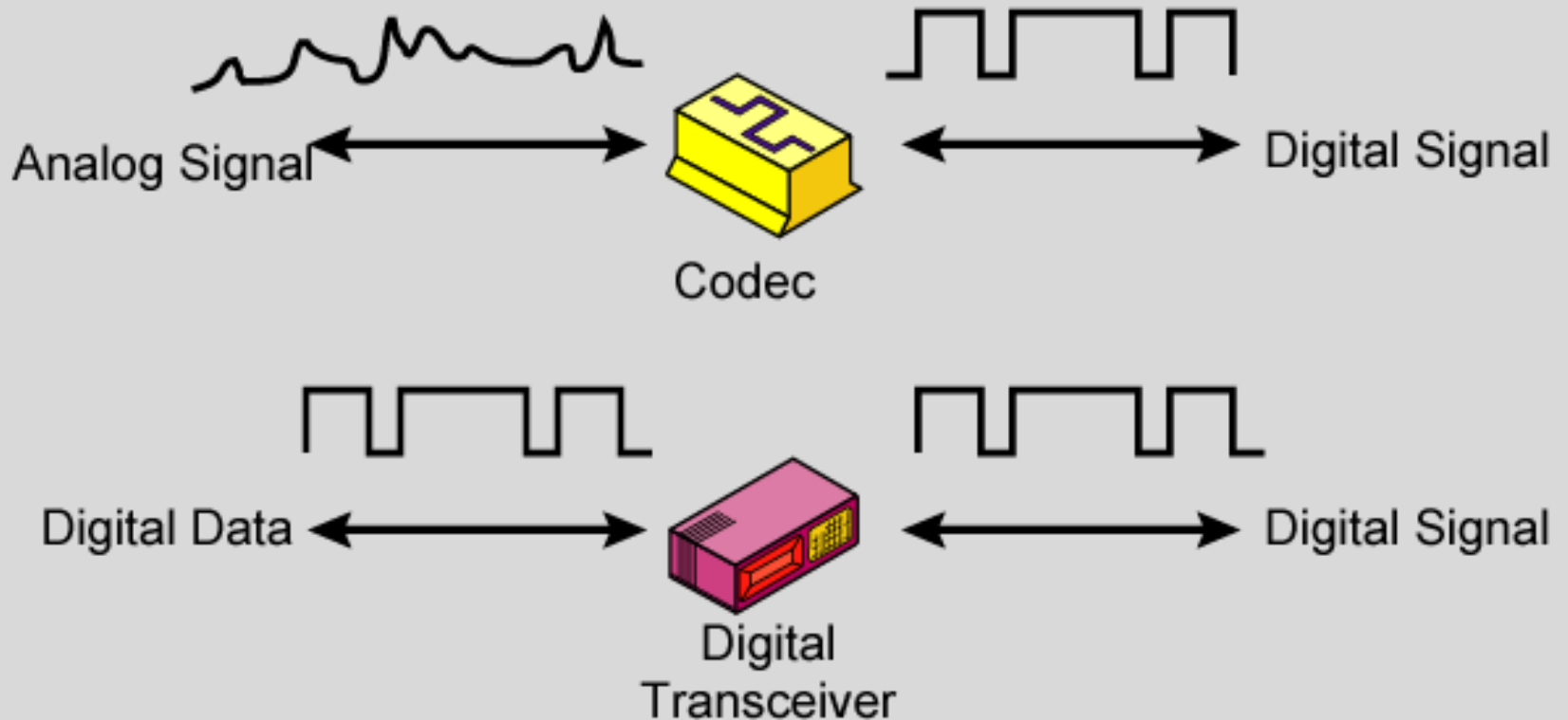

Digital Data, Digital Signal

Encoding (Κωδικοποίηση)

- ❖ Signals propagate over a physical medium
 - modulate electromagnetic waves
 - e.g., vary voltage
- ❖ Encode binary data onto signals
 - binary data must be encoded before modulation
 - e.g., **0 as low signal** and **1 as high signal**
 - known as Non-Return to zero (NRZ)

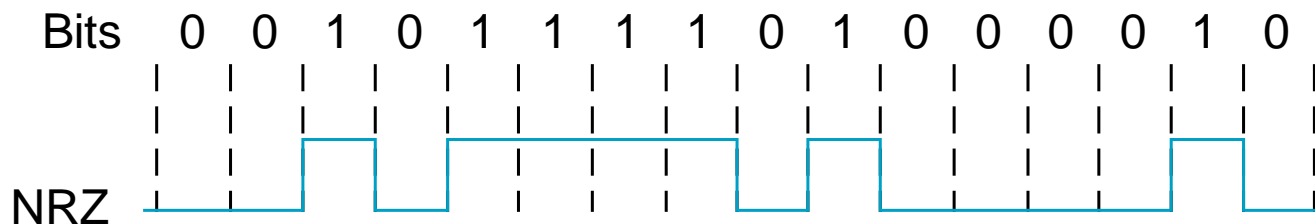

Encodings (cont)

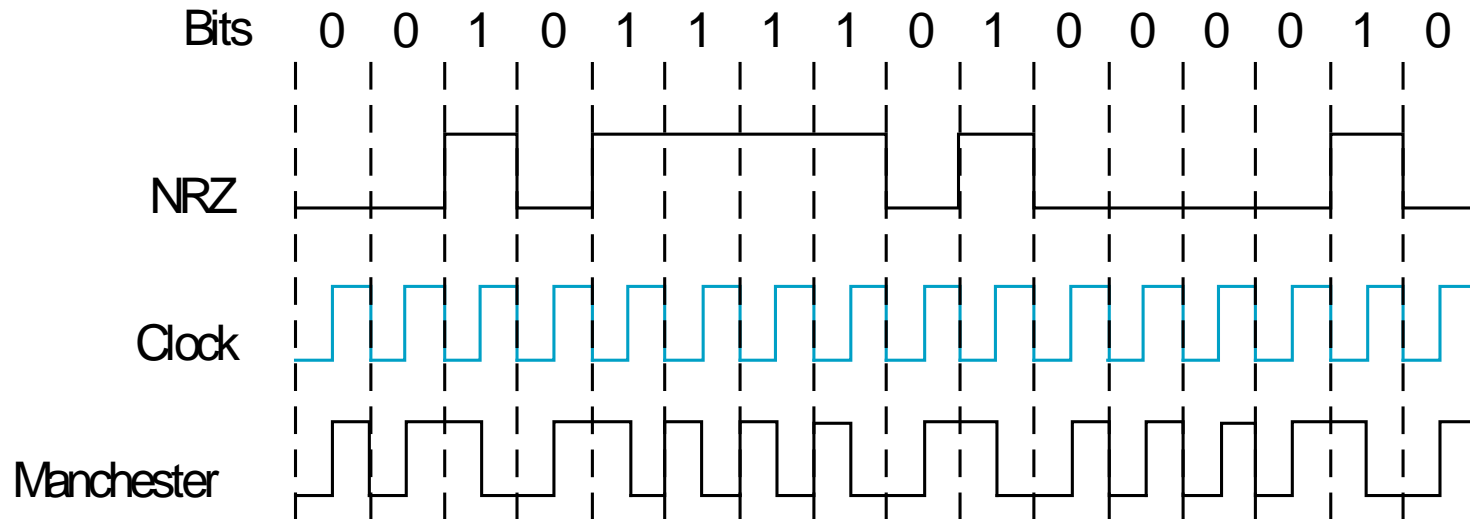

If the encoded data contains long 'runs' of logic 1's or 0's, this does not result in any bit transitions. The lack of transitions makes impossible the detection of the boundaries of the received bits at the receiver.

This is the reason why Manchester coding is used in Ethernet.

Other Encoding Schemes

- ❖ Unipolar NRZ
- ❖ Polar NRZ
- ❖ Polar RZ
- ❖ Polar Manchester and Differential Manchester
- ❖ Bipolar AMI and Pseudoternary
- ❖ Multilevel Coding
- ❖ Multilevel Transmission 3 Levels
- ❖ RLL

The Waveforms of Line Coding Schemes

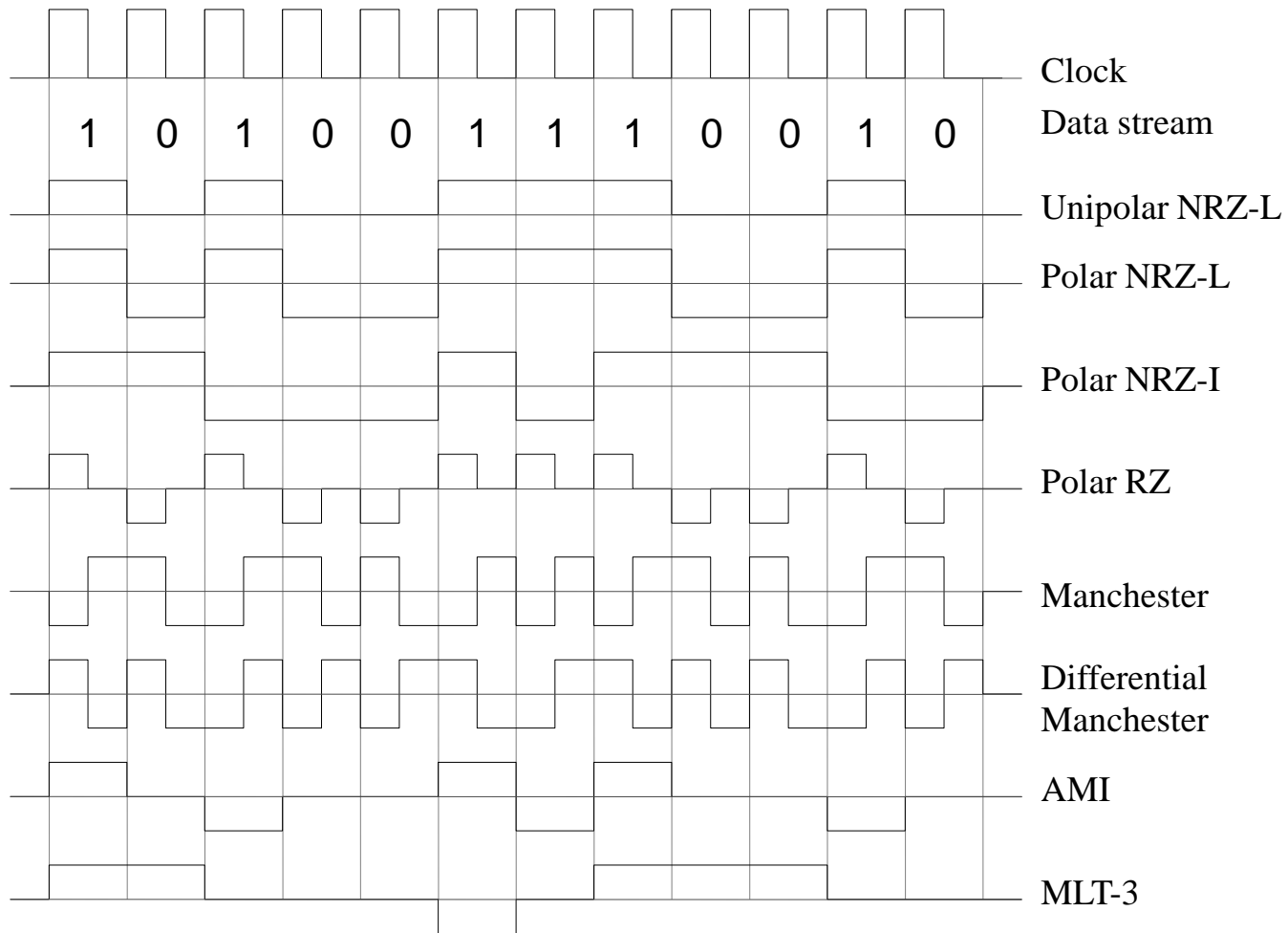

Bandwidths of Line Coding (2/3)

- The bandwidth of Manchester.

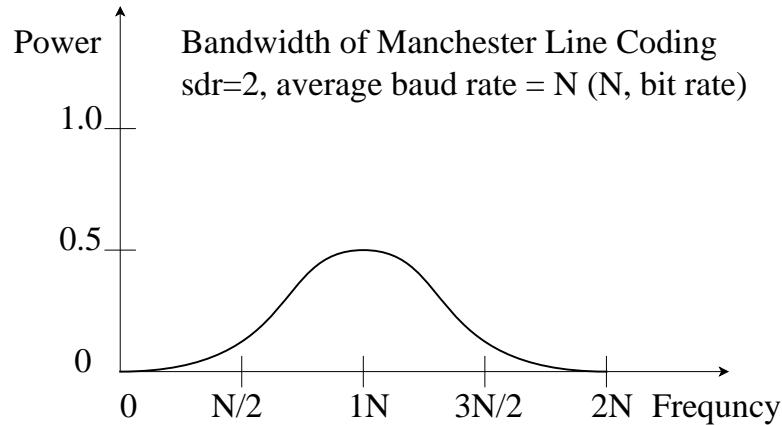

- The bandwidth of AMI.

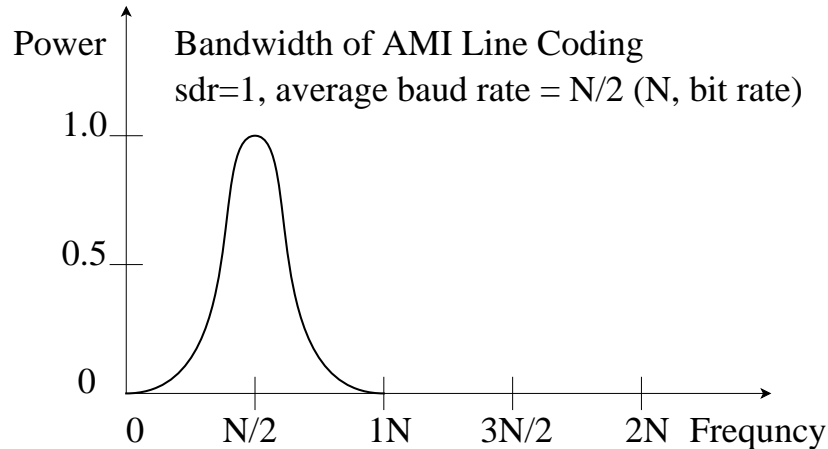

Bandwidths of Line Coding (3/3)

- The bandwidth of 2B1Q

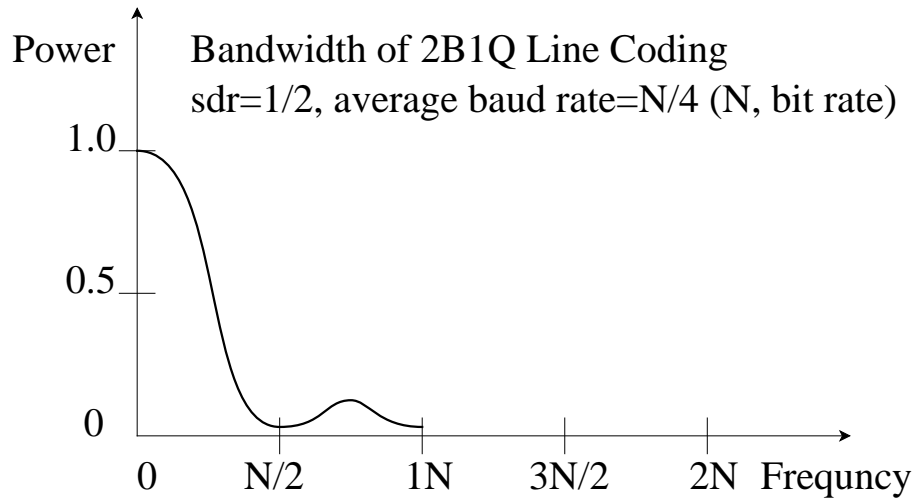

Digital Data, Analog Signal

- ❖ After encoding of digital data, the resulting digital signal must be modulated before transmitted
- ❖ Use modem (**m**odulator-**d**emodulator)
 - Amplitude shift keying (ASK)
 - Frequency shift keying (FSK)
 - Phase shift keying (PSK)

Modulation Techniques

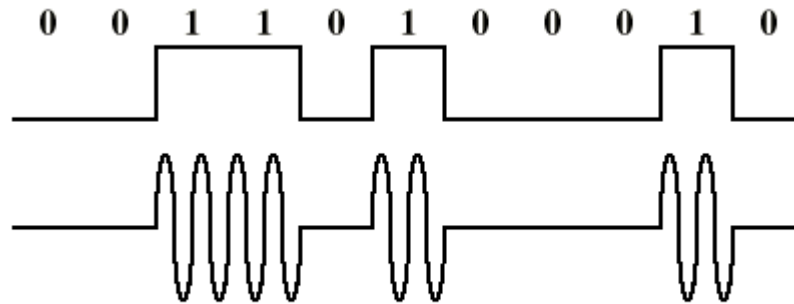

(a) Amplitude-shift keying



(b) Frequency-shift keying



(c) Phase-shift keying

Constellation Diagram (1/2)

- ❖ A constellation diagram: constellation points with two bits: b_0b_1

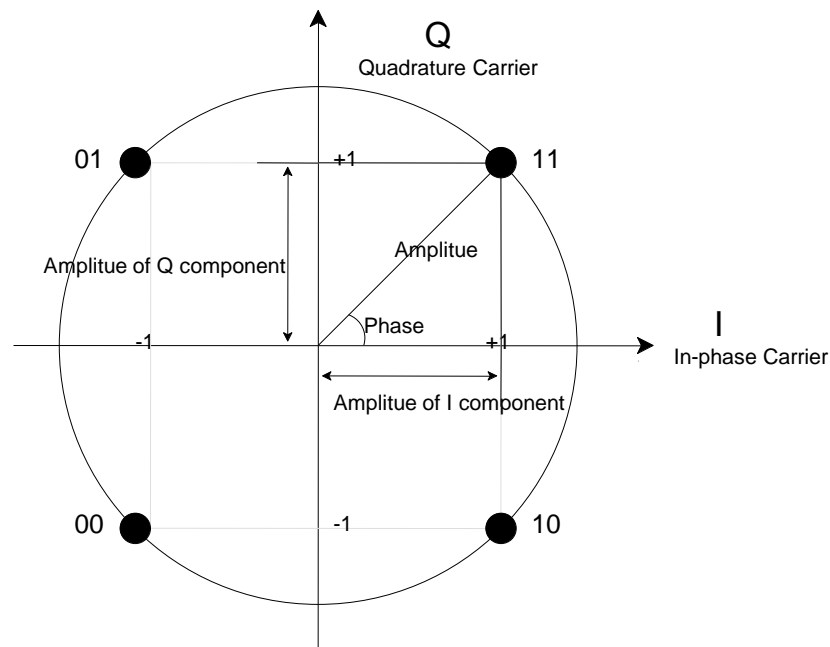

Amplitude Shift Keying (ASK) and Phase Shift Keying (PSK)

❖ The constellation diagrams of ASK and PSK.

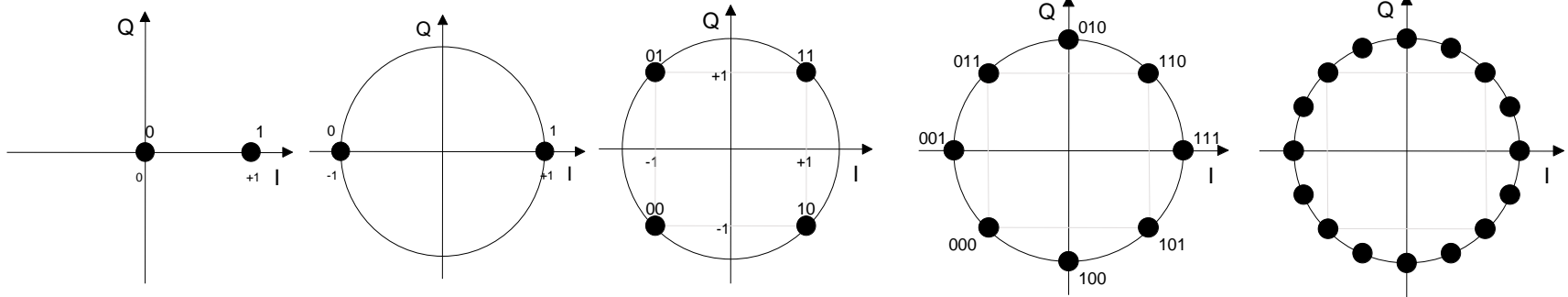

(a) ASK (OOK): b_0

(b) 2-PSK (BPSK): b_0

(c) 4-PSK (QPSK): b_0b_1

(d) 8-PSK: $b_0b_1b_2$

(e) 16-PSK: $b_0b_1b_2$

The Circular Constellation Diagrams

- ❖ The constellation diagrams of ASK and PSK.

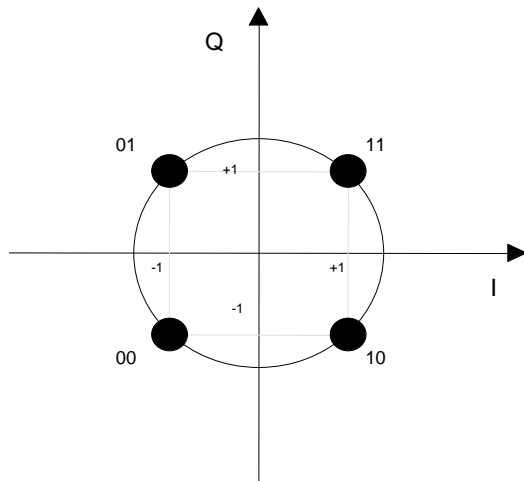

(a) Circular 4-QAM: b0b1

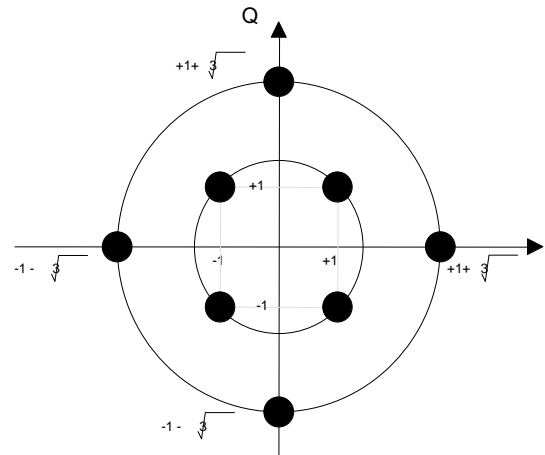

(b) Circular 8-QAM: b0b1b2

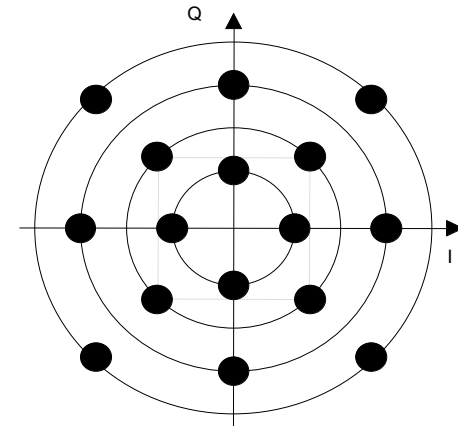

(c) Circular 16-QAM: b0b1b2b3

The Rectangular Constellation Diagrams

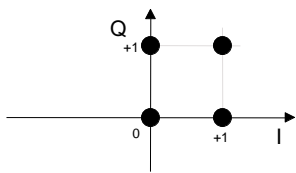

(a) Alternative Rectangular 4-QAM: b0b1

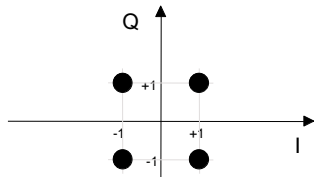

(b) Rectangular 4-QAM: b0b1

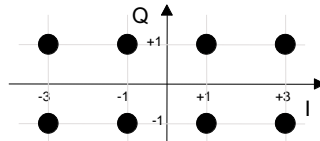

(c) Alternative Rectangular 8-QAM: b0b1b2

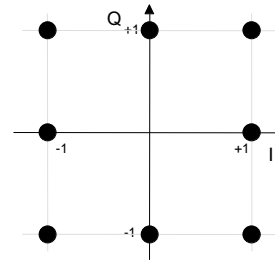

(d) Rectangular 8-QAM: b0b1b2

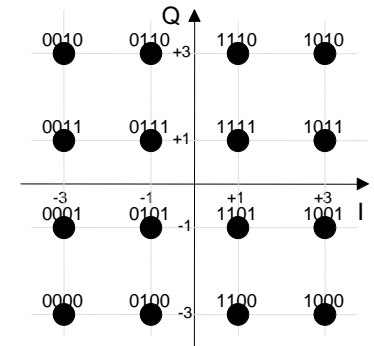

(e) Rectangular 16-QAM: b0b1b2b3

Quadrature PSK

- ❖ More efficient use if each signal element (symbol) represents more than one bit
 - e.g. shifts of $\pi/2$ (90°) \rightarrow 4 different phase angles
 - Each element (symbol) represents two bits
 - With 2 bits we can represent the 4 different phase angles
 - E.g. Baud rate = 4000 symbols/sec and each symbol has 8 states (phase angles). Bit rate=??
 - **If a symbol has M states \rightarrow each symbol can carry $\log_2 M$ bits**
 - Can use more phase angles and have more than one amplitude
 - E.g., 9600bps modem use 12 angles, four of which have two amplitudes

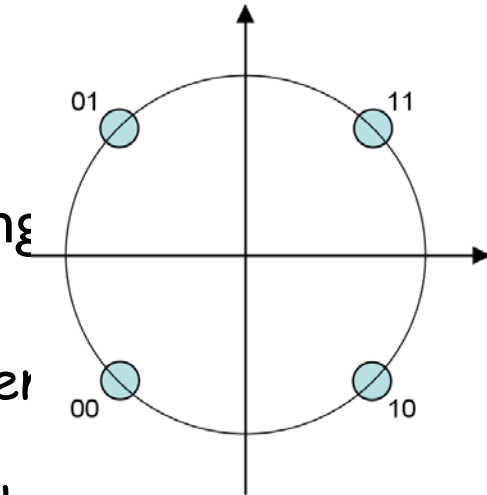

Modems (2)

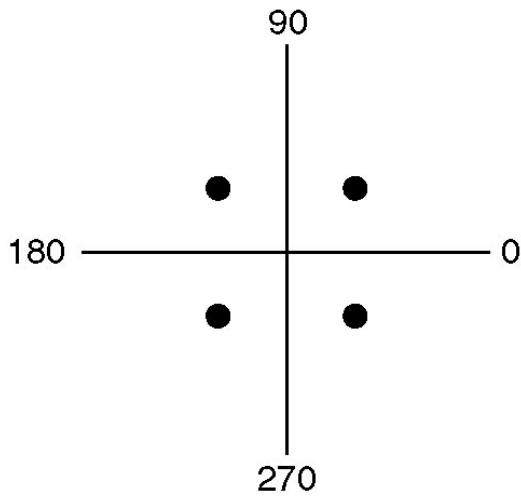

(a)

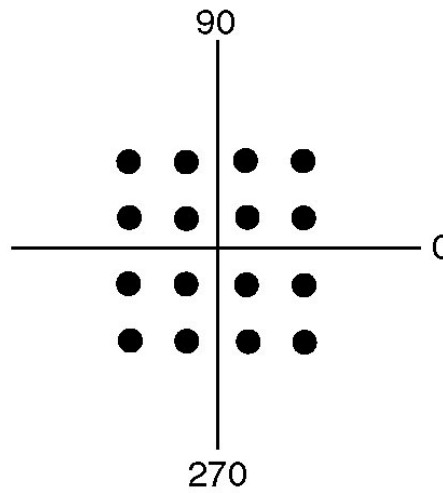

(b)

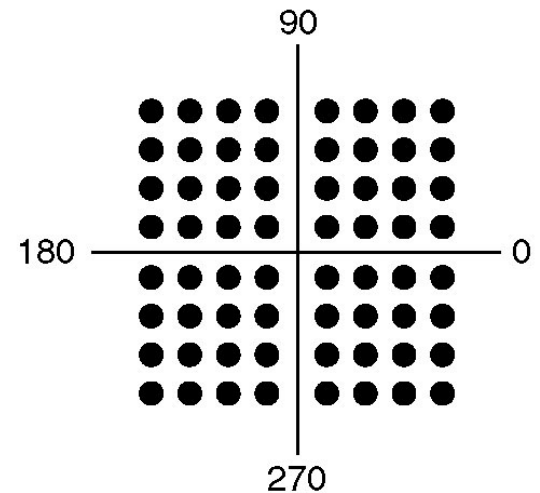

(c)

(a) QPSK.

(b) QAM-16.

(c) QAM-64.

Modems (3)

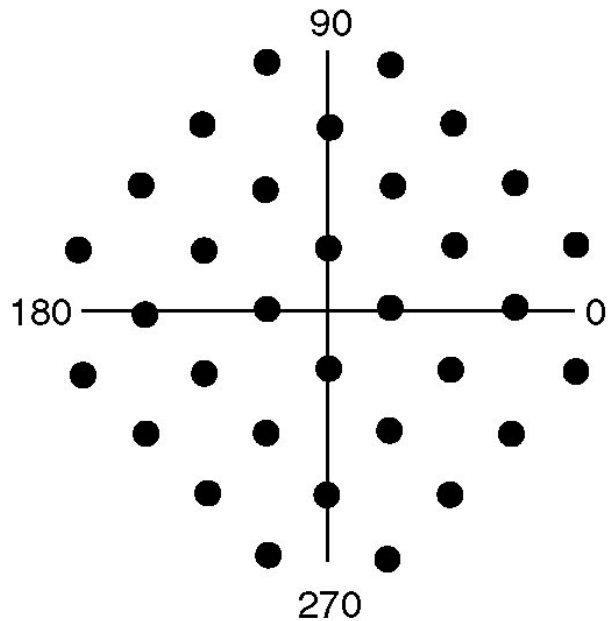

(a)

(a) V.32 for 9600 bps.

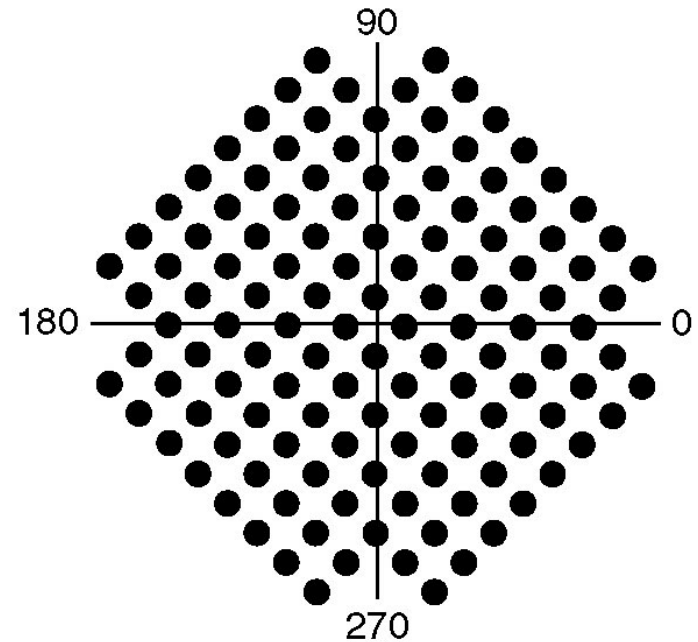

(b)

(b) V32 bis for 14,400 bps.

2-D signal

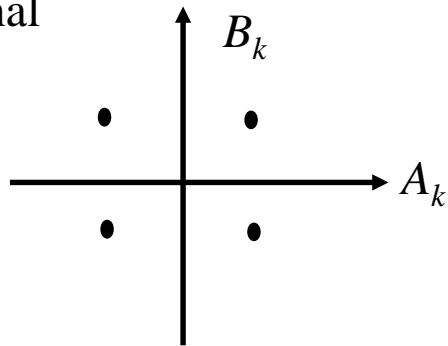

4 “levels”/ pulse
2 bits / pulse
 $2W$ bits per second

2-D signal

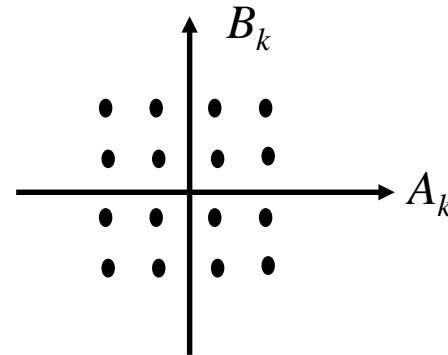

16 “levels”/ pulse
4 bits / pulse
 $4W$ bits per second

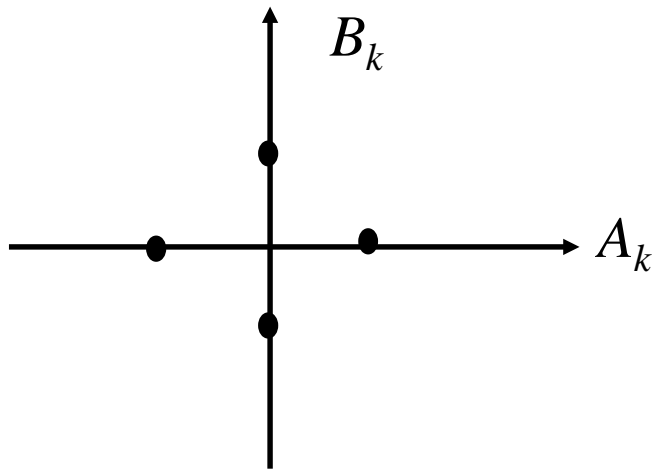

4 “levels”/ pulse
 2 bits / pulse
 2W bits per second

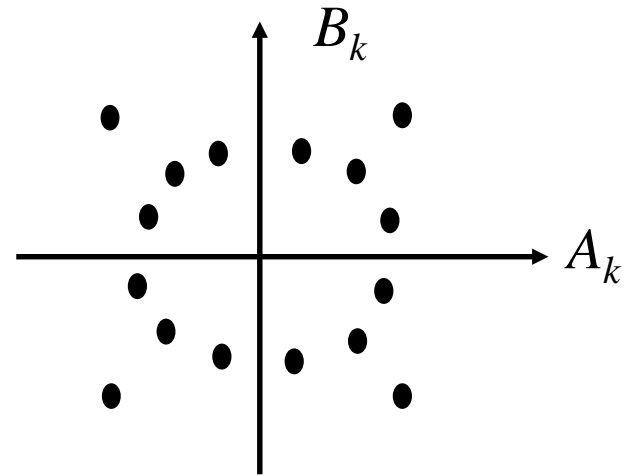

16 “levels”/ pulse
 4 bits / pulse
 4W bits per second

Analog Data, Digital Signal

Signal Sampling and Encoding

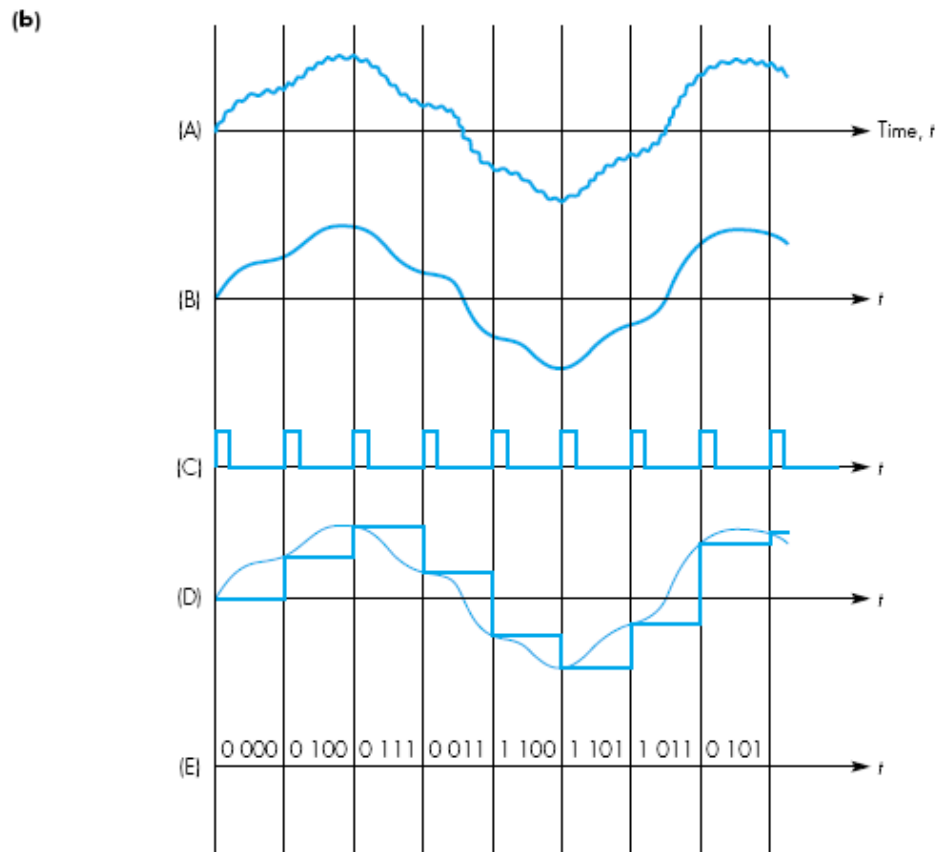
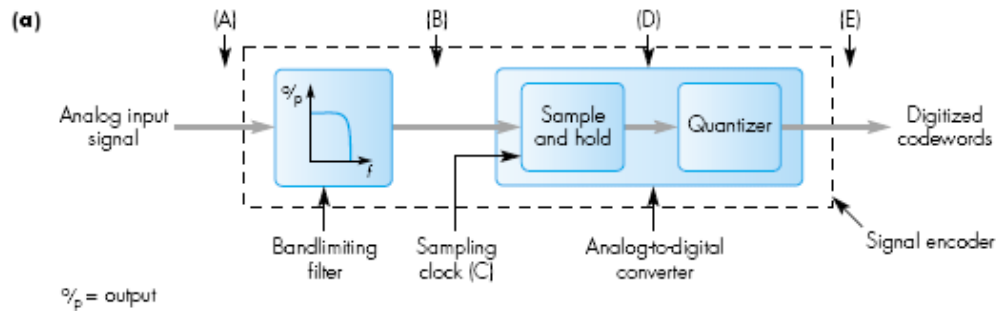

Digital Signal Decoding

(a)

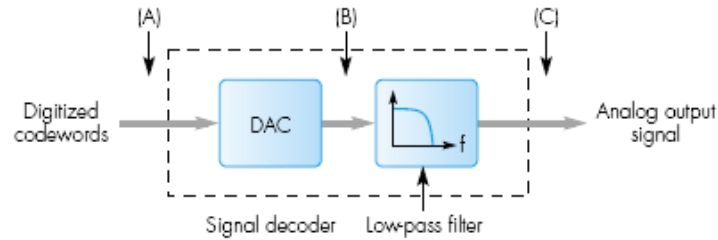

(b)

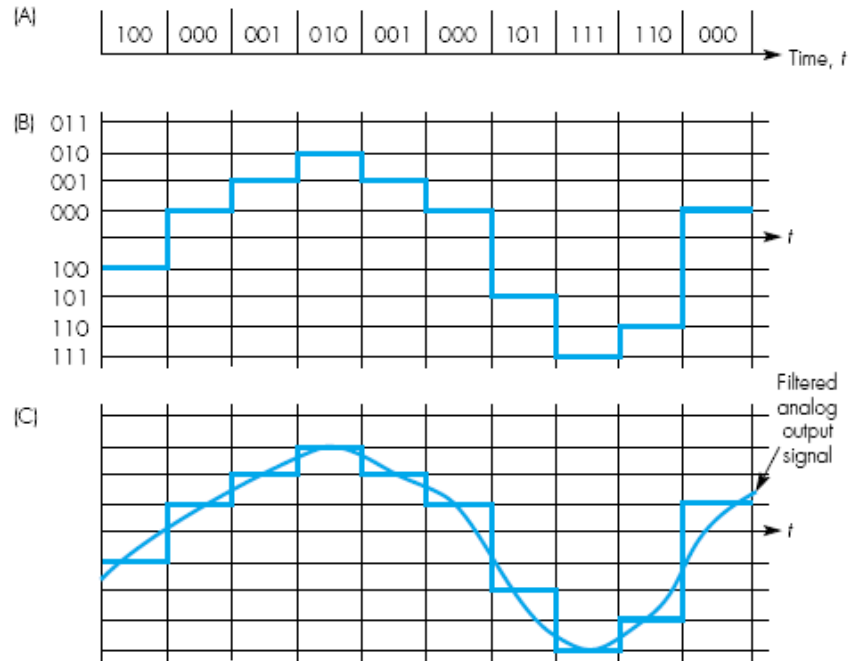

Alias generation due to undersampling

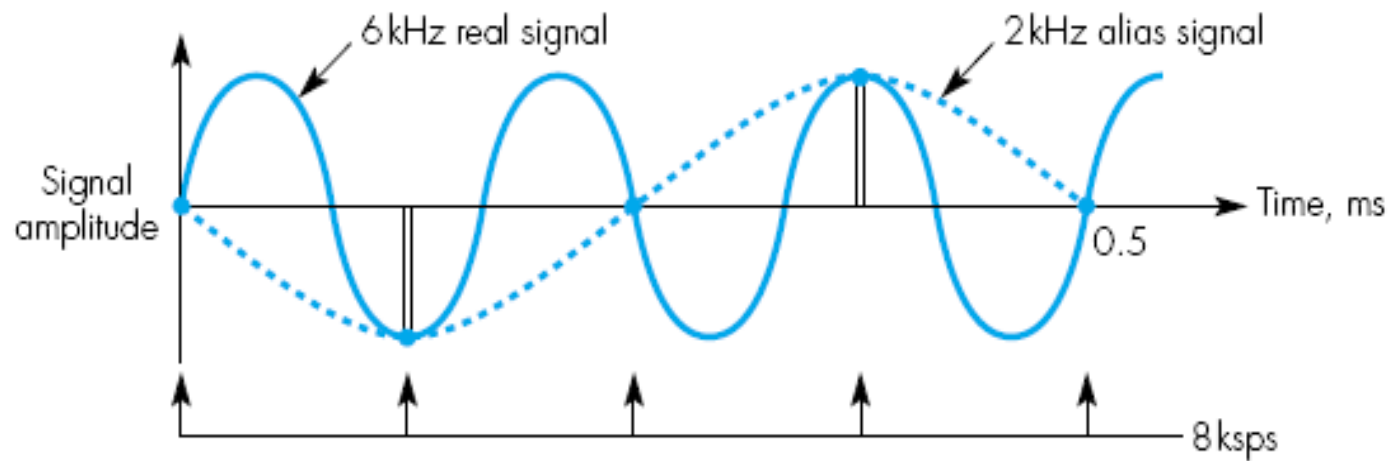

Nyquist Bandwidth

- ❖ If rate of signal transmission is $2B$ then signal with frequencies no greater than B is sufficient to carry signal rate
- ❖ Given bandwidth B , highest signal (baud) rate is $2B$
- ❖ Given binary signal, data rate supported by B Hz is $2B$ bps (if each symbol carries one bit)
- ❖ Can be increased by using M signal levels
- ❖ $C = 2B \log_2 M$

Transmission Impairments

- ❖ Signal received may differ from signal transmitted
- ❖ Analog → degradation of signal quality
- ❖ Digital → bit errors
- ❖ Caused by
 - Attenuation and attenuation distortion
 - Delay distortion
 - Noise

Attenuation

- ❖ Signal strength falls off with distance
- ❖ Depends on medium
- ❖ Received signal strength:
 - must be enough to be detected
 - must be sufficiently higher than noise to be received without error
- ❖ Attenuation is an increasing function of frequency

Noise (I)

- ❖ Additional signals inserted between transmitter and receiver
- ❖ Thermal
 - Due to thermal agitation of electrons
 - Uniformly distributed
 - White noise
- ❖ Intermodulation
 - Signals that are the sum and difference of original frequencies sharing a medium

Noise (2)

❖ Crosstalk

- A signal from one line is picked up by another

❖ Impulse

- Irregular pulses or spikes
- e.g. External electromagnetic interference
- Short duration
- High amplitude

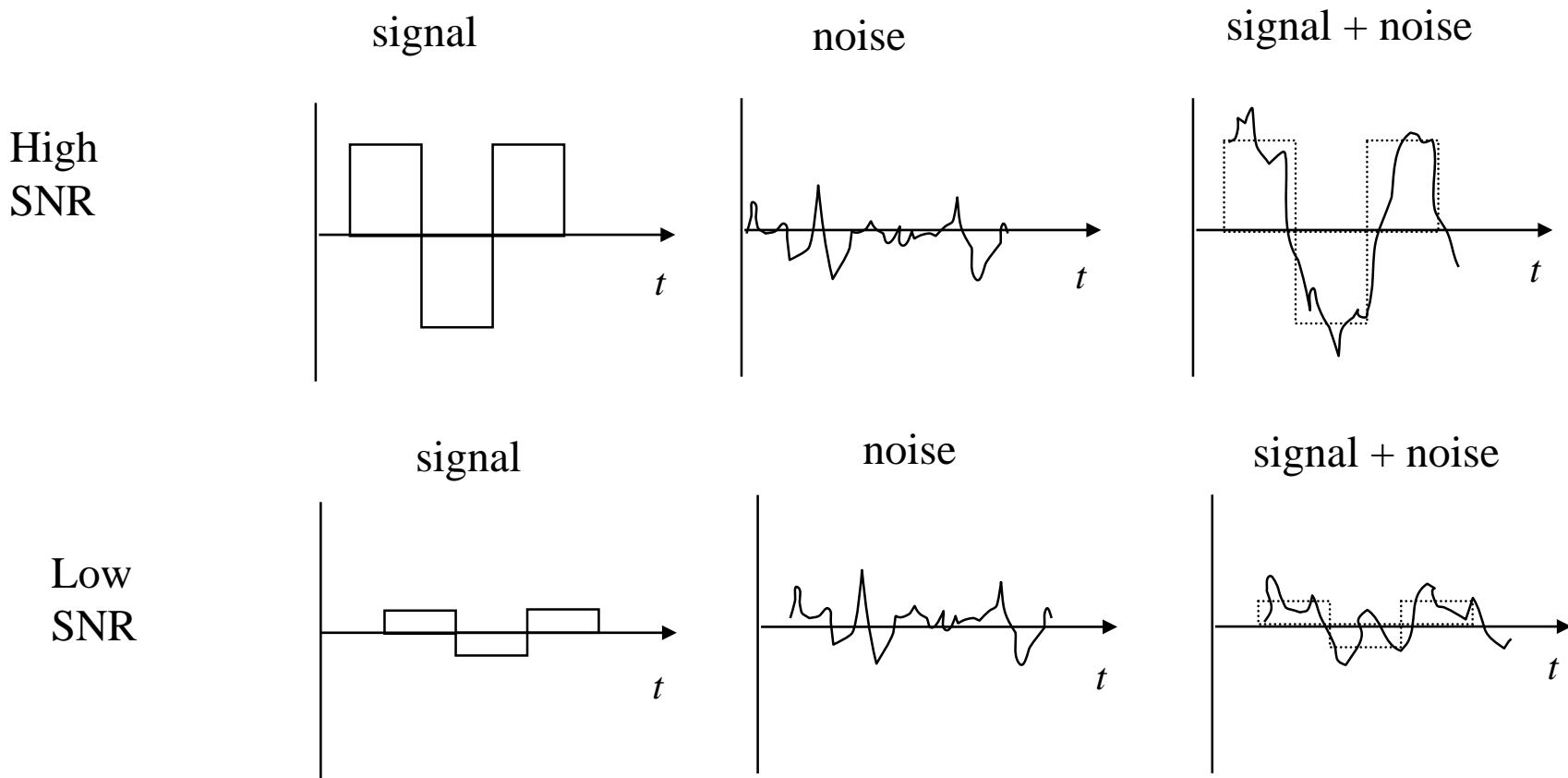

$$\text{SNR} = \frac{\text{Average Signal Power}}{\text{Average Noise Power}}$$

$$\text{SNR (dB)} = 10 \log_{10} \text{SNR}$$

Shannon's Theorem

Real communication have some measure of noise. This theorem tells us the limits to a channel's capacity (in bits per second) in the presence of noise. Shannon's theorem uses the notion of **signal-to-noise ratio (S/N)**, which is usually expressed in decibels (dB):

$$dB = 10 \times \log_{10}(S / N)$$

Shannon's Theorem – cont.

Shannon's Theorem: $C = B \log_2(1 + (S / N))$

C: achievable channel rate (bps)

B: channel bandwidth

For POTS, bandwidth is 3000 Hz (upper limit of 3300 Hz and lower limit of 300 Hz), S/N = 1000

$$C = 3000 \log_2(1 + 1000) \approx 30\text{Kbps}$$